



INSTALLATION AND OPERATING INSTRUCTIONS

安裝使用說明書

Thermo Ventilator 浴室換氣暖風機

Model No.
型號: 23BWDBH

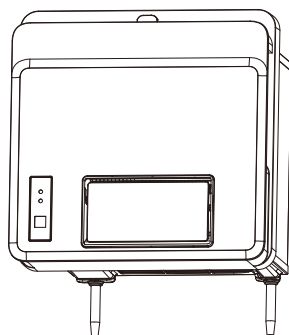

CONTENTS	
SAFETY INSTRUCTIONS	2
INSTALLATION INSTRUCTIONS	3~4
INSTALLATION REQUIREMENTS	5~6
SUPPLIED ACCESSORIES	6
PART NAMES AND DIMENSIONS	7
HOW TO INSTALL	7~14
TEST RUN	14~15
FUNCTION OF REMOTE CONTROL	15
HOW TO USE TIMER FUNCTION	16
HOW TO USE AIR DIRECTION FUNCTION	17
HOW TO USE HEATING FUNCTION	18
HOW TO USE VENTILATION FUNCTION	19
HOW TO USE DRY HOT/COOL FUNCTION	19~21
MODE BUTTON PANEL ON MAIN BODY	22
USE AND MAINTENANCE INSTRUCTIONS	23~25
HOW TO MAINTENANCE	25~26
ANTIBACTERIAL FUNCTION	26
TROUBLESHOOTING	27
WIRING DIAGRAM	27
SPECIFICATIONS	BACK COVER

目錄	
安全指引	2
安裝注意事項	3~4
安裝要求	5~6
包裝附件清單	6
部件名稱和尺寸	7
安裝方法	7~14
試運轉	14~15
遙控器功能	15
定時功能的使用方法	16
風向功能的使用方法	17
取暖功能的使用方法	18
換氣功能的使用方法	19
熱/涼乾燥功能的使用方法	19~21
機體模式按鈕面板	22
使用及維護注意事項	23~25
維護方法	25~26
抗菌功能	26
常見故障的識別與處理	27
電氣原理圖	27
規格	末頁

Thank you for purchasing this KDK product. Please read these instructions carefully before attempting to install, operate or service the KDK product. Please carefully read "INSTALLATION INSTRUCTIONS" (P.3~4) of this instructions before installation. Failure to comply with instructions could result in personal injury or property damage. Please explain to users how to operate and maintain the product after installation, and this booklet should be presented to users. Please carefully read "USE AND MAINTENANCE INSTRUCTIONS" (P.23~25) of this instructions before operation. Please retain this booklet for future reference.

感謝您選用KDK產品。
安裝、使用和保養KDK產品前，請仔細閱讀本安裝使用說明書。安裝前，請務必先閱讀“安裝注意事項”（第3~4頁）。不遵照此說明書進行操作有可能導致人員受傷或財產損失。安裝完成後，請向顧客說明如何使用和維護KDK產品，並將此說明書交給顧客保管。使用前，請務必先閱讀“使用及維護注意事項”（第23~25頁）。請妥善保管好此說明書以備日後參考。

- Disconnect power supply before maintenance.

維護保養前先斷電。

- This appliance is not intended for use by persons (including children) with reduced physical, sensory or mental capabilities, or lack of experience and knowledge, unless they have been given supervision or instruction concerning use of the appliance by a person responsible for their safety. Children should be supervised to ensure that they do not play with the appliance.

本產品不適合有殘疾、智障或精神障礙的人士或缺乏經驗、常識者(包括兒童)維護使用，除非在負責他們安全的人士的看護或指導下使用。兒童應該有人進行看護，以防將產品當做玩具。

The following instructions should be strictly observed in order to prevent injury to the users and other people, or damage to property.

為避免給您及其他人造成傷害，這裡我們列出了以下安全注意事項，請務必遵守，各種標誌的含意請參見以下內容。

- The degrees of injury or damage that can occur when the instructions are ignored and if the product is not used properly have been classified and described by the following indications.

對無視表示內容，錯誤地使用時，會引起的危害或損傷的程度，用下列符號進行分類、說明。



This indication means: Must be treated seriously that this may result in death or serious injury.

本標誌所表示內容為“不遵守的話可能造成人員死亡或重傷”。



This indication means: Must be treated seriously that this may result in injury or physical damage.

本標誌所表示內容為“不遵守的話可能造成人身輕傷或其他財產損害”。

- Types of instructions that should be observed have been classified and described by the following pictorial symbols.

對希望遵守的內容和種類，用下列符號進行分類、說明。



This symbol indicates the item is “PROHIBITED” to do.
此標誌表示為禁止事項



This symbol indicates the “COMPULSORY” item that must be followed without failure.
此標誌表示為強制事項



This symbol indicates the item is “CAUTION”.
此標誌表示為提示注意事項



WARNING

警告

- The product must be grounded.

必須接地。



Otherwise, it may cause electric shock when there is any trouble or electric leakage.

當出現故障或漏電時，可能會觸電。

- Do not install the product as the method which is not approved in the instruction.

禁止使用本說明書指定以外的方法進行安裝。



Otherwise, unreliable installation may be caused and thus the product may fall off, resulting in injuries.

否則可能會安裝不牢固，導致產品掉落受傷。

- To avoid danger arising from wrong resetting of the thermal circuit breaker, the product can not be powered by using an external switch. For example, by a timer or connecting to a circuit that is connected/disconnected through timing of a universal part.

為避免由熱斷路器的誤復位產生危險，產品不能通過外部開關裝置供電。例如，定時器或者連接到由通用部件定時進行通、斷的電路。



Otherwise, a fire may be caused.

否則可能會導致火災。

- Do not close to curtains and other flammable materials when install the product.

禁止靠近窗簾和其他可燃材料安裝。



Otherwise, combustibles may be inflamed.

否則可能會引燃可燃物。

- The product can not be located just below a power outlet socket.

禁止把本產品安放在電源插座下使用。



Otherwise, a fire may be caused.

否則可能會導致火災。

- Do not operate the product other than the rated voltage (220 V~, 50 Hz).

禁止使用額定電壓(220 V~, 50 Hz)以外的電壓。



Otherwise, it may cause damages to the product or a fire.

否則可能會損壞本產品或導致火災。

- Do avoid the back-flow of gas into the room from the open flue of flammable gas or other open-fire appliances.

必須避免易燃氣體從敞開的氣道或其他燃燒燃料的設備回流進室內。



Otherwise, a fire may be caused.

否則可能會導致火災。

- Please install an suitable all-pole switch which the contact separation is more than 3 mm. Please install the all-pole switch out of the bathroom where it is easily controlled.

安裝時，須在供電線路中安裝其觸點開距不小於3 mm的合適的“電源全極開關”，以用於接通或斷開主機電源，且安裝在浴室外側方便操作的地方。



Otherwise, it may cause a short circuit, thus resulting a fire.

否則可能會導致短路，導致火災。

- Please select 60227 IEC 53 ordinary polyvinyl chloride sheathed cord. Nominal cross-sectional area of conductors is $3 \times 1.5 \text{ mm}^2$.

電源線請選用60227 IEC 53型軟線，導線的截面積為 $3 \times 1.5 \text{ mm}^2$ 。



Otherwise, it may be on fire.

否則可能會導致起火。

- Make sure the power cord is installed firmly.

確保電源線安裝到位。



Otherwise, a fire may be caused.

否則可能會導致火災。

**WARNING**
警告

- The product must be installed by professionals or trained personnel with equivalent expertise and skills according to the national wiring rules.

必須由專業人員或經培訓等具備同等專業知識和技能的人員按照國家佈線規則進行安裝。



Otherwise, electric leakage, electric shock or a fire may be caused due to wrong wiring, twisted wiring or wire clamping.
否則可能會因錯誤接線、扭絞接線、夾線等而導致漏電、觸電、火災。

- The product is installed so that switches cannot be touched by a person in the bath or shower.
產品的安裝，應使得浴缸內或淋浴區的人不能夠觸及到開關。



Otherwise, an electric shock may be caused.
否則可能會導致觸電。

- Disconnect power source before working on the product.

安裝、維修保養時必須斷開電源。



Otherwise, an electric shock may be caused.
否則可能會導致觸電。

**CAUTION**
注意

- Do not reconstruct this product.
禁止對本產品進行改造。



Otherwise, it may cause damage to the product.
否則可能會導致產品損壞。

- Do fix this product tightly.
機體安裝必須牢固。



Otherwise, it may fall off or cause personal injury.
否則可能會掉落，導致受傷。

- Components must be installed tightly.
部品安裝必須牢固。



Otherwise, it may fall off or cause personal injury.
否則可能會掉落，導致受傷。

- It is recommended that two persons perform the installation of the product.
建議兩人進行產品的安裝作業。



Otherwise, it may cause the product to fall off.
否則可能會導致產品掉落。

- Do not install it on window without sufficient strength. It must be subject to 5 times the weight of the product. If you cannot ensure the installation strength, be sure to adopt reinforcement measure.

產品必須安裝在強度足夠的窗體上，需可承受產品5倍的重量，如不能確保安裝強度，請務必採取加固措施。



Otherwise, it may fall off or cause personal injury.
否則可能會掉落，導致受傷。

- The special-purpose or dedicated parts, such as mounting fixtures, must be used if such parts are provided.

有安裝五金件等專用零部件時，應使用專用零部件。



Otherwise, unreliable installation may be caused and thus the product may fall off.
否則可能會安裝不牢固，導致產品掉落。

- Do not install onto slanting window.
請勿安裝在傾斜的窗體上。

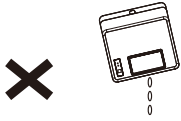

Prevent the water condensed in the duct pipe flow back into the body.
防止水倒流。

- Do not install the product in steam sauna bathroom.
請勿安裝在桑拿蒸氣浴室中。



Maybe it can cause breakdown.
可能會引起故障。

- Do not install the product in the places where the sprayer is used.
請勿安裝在使用噴霧器的場所。



Maybe it can cause breakdown.
可能會引起故障。

- Do not install the product in places with high temperature.
請勿安裝在高溫的環境下。

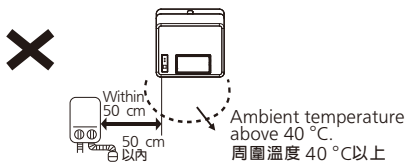

Maybe it can cause breakdown.
可能會引起故障。

- Please set ventilation holes.
請設置通風口。

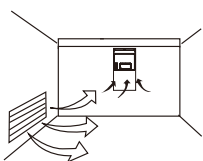

- The product is not provided with power cord, all-pole switch and leakage protection switch (with the leakage current lower than 30 mA). Please purchase them in market.
本產品沒有提供電源線，電源全極開關和漏電保護開關(洩漏電流在30 mA以下)，需用戶另購。

- Please make sure the product installed horizontally and the deviation angle within the range as below figure.
請確保整機水平安裝偏差角度在下圖所示範圍內。

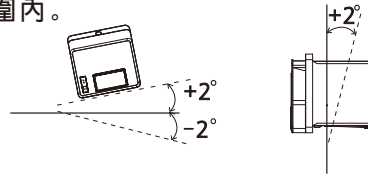

- Do not install the product in the places where the organic solvent is used.
請勿安裝在使用有機溶劑的場所。

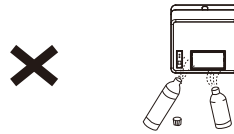

Maybe it can cause breakdown.
可能會引起故障。

- Do not install the product where it is exposed to oil mist.
請勿安裝在油煙過多的場所。

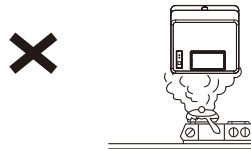

Maybe it can cause breakdown.
可能會引起故障。



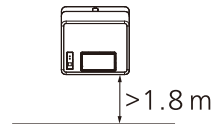





- The product must be installed over 1.8 m above the floor.
產品安裝高度距地面必須大於1.8 m。



- Do not cover air outlet, maybe it can cause breakdown.
請勿覆蓋產品出風口，否則可能會引起機體故障。
- When you install plastic part, do not exert too much strength to fixing the screw (the recommended screw fixing torque is 0.78 N·m), otherwise, the product would be damaged.
安裝塑料部件時，為了不損壞產品，鎖螺絲時請注意不要用力過大(建議鎖緊扭矩為0.78 N·m)。
- Do not install this product in a public bath room.
請勿把本產品安裝在公共浴室。
- Do not install this product in a wardrobes.
請勿把本產品安裝在衣櫃內。
- In extreme weather condition(rainfall precipitation more than 240 mm/h. wind speed higher than No.8 typhoon.), there may be water through frame into bathroom.
在極端惡劣的天氣條件下(雨量大於240 mm/h，風速大於8號風球)，可能會有水通過產品框架進入浴室內部。

SUPPLIED ACCESSORIES

包裝附件清單

No. 代號	Drawing 圖樣	Name and purpose 名稱及用途	Qty 數量
①		Machine screw (M4×10, used to install the louver assembly) 機械螺絲(M4×10用於面板組合安裝)	1
②		Self-tapping screw (φ4×16, used to install the controller holder) (placed on the backside of controller holder) 自攻螺絲(φ4×16用於遙控器底座安裝)(放置於遙控器底座背面)	2
③		Self-tapping screw (φ4×25, used to install the main body and the window) 自攻螺絲(φ4×25用於機體與窗體的安裝)	4
④		Product warranty registration 產品保修登記	1
⑤		Installation and operating instructions 安裝使用說明書	1
⑥		Remote control panel Chinese card 遙控面板中文卡	1
⑦		Louver assembly 面板組合	1
⑧		Remote control (included CR2032 battery) 遙控器(內附CR2032電池)	1

Unit: mm 單位: mm

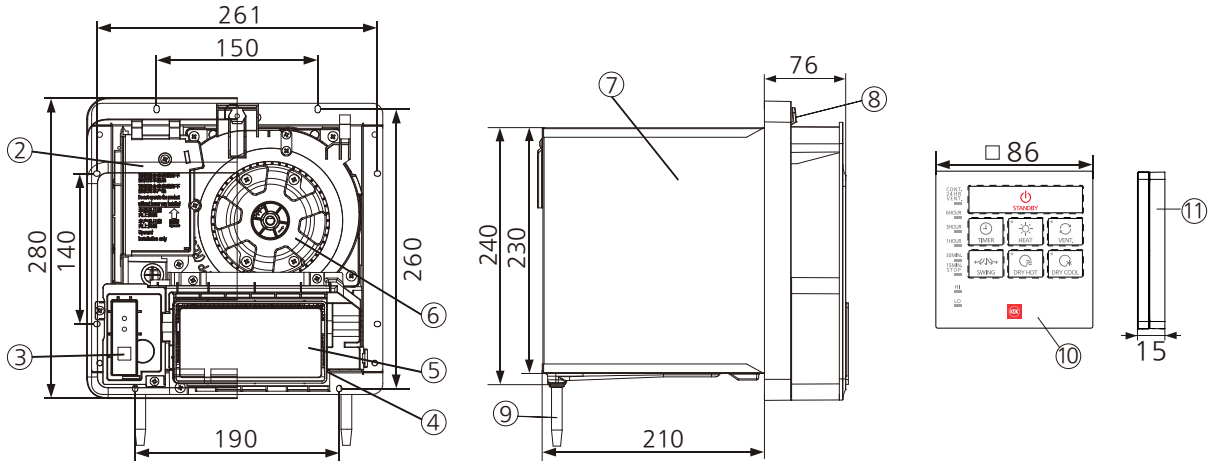

No. 序號	Part name 部件名稱	No. 序號	Part name 部件名稱
①	Louver assembly 面板組合	⑦	Main body 機體
②	Cord cover 接線蓋板	⑧	Filter assembly 過濾網組合
③	Signal receiver 信號接收器	⑨	Drain 排水管
④	Heater assembly 加熱器組合	⑩	Remote control 遙控器
⑤	Baffle plate 導風板	⑪	Controller holder 遙控器底座
⑥	Fan 扇葉		

HOW TO INSTALL

安裝方法

1. Installation diagram (Top View) 安裝俯視示意圖

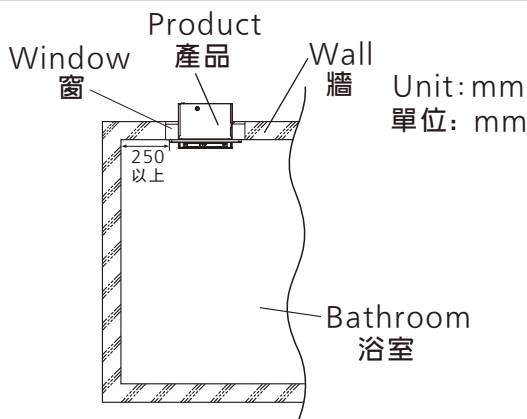

Notice 提示事項

Install this product over 200 mm apart from curtains or other flammable materials. (When the mounting hole is adjacent to curtains or other flammable materials, ensure that more than 250 mm gap is required between the hole edge and wall.)

離窗簾和其他易燃材料距離200 mm以上。(安裝孔鄰近窗簾和其他易燃材料時，需保證開口邊緣距牆壁的距離在250 mm以上。)

The bathroom size may affect the heating performance of this product. 浴室大小的不同會影響本產品的暖房效果。

2. Recommended main body installation method

建議的機體安裝方法

- ① This product can be installed on a window which size is shown as right figure. A window frame needs to be made according to the window and main body dimensions.

本產品適用於右圖所示尺寸大小的窗體安裝，請根據窗體結構及機體尺寸製作窗體。

Product installation dimensions
(minimum opening dimensions)

產品安裝尺寸(最小開口尺寸)

(width)238 mm×(height)242 mm

(寬) 238 mm×(高) 242 mm

Window frame material: recommend the use of aluminum alloy.

窗體材質：推薦使用鋁合金

Window frame thickness: less than 30 mm

窗體厚度：小於30 mm

Notice

提示事項

It may be difficult to remove the filter if little clearance between product and ceiling.

產品與天花板之間要確保有足夠的空間，否則會導致產品過濾網拆卸困難。

- ② Fix the window frame onto the original window.
(It must be can bear 5 times weight of the product.)

將窗體用可靠方法固定於原有窗框上。

(需能承受產品5倍的重量)



Please be sure to take sufficient protection measure to prevent from high falling when install window frame.

安裝窗體時，請務必採取足夠的防護措施，以防窗體高空掉落。

- ③ Add silicone to seal around the flange of product, to make sure that the silicone cover the entire surface of sponge.

在產品法蘭邊周圍加玻璃膠，並確保玻璃膠覆蓋整個海綿表面。

- ④ Please put the lower part of the product into the window sill first when it is installed, which to make sure the drain does not fall off.

將機體安裝到窗體時，先將機體下部放入窗體并確保排水管沒有脫落。

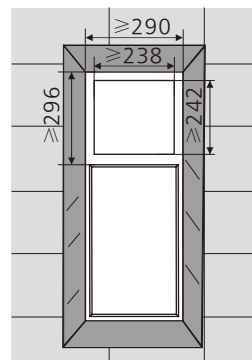

Unit: mm
單位: mm

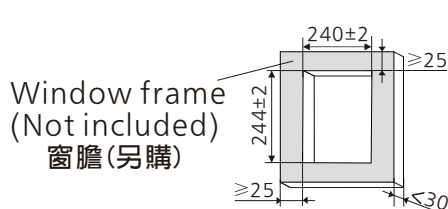

Unit: mm
單位: mm

Window frame
(Not included)
窗體(另購)

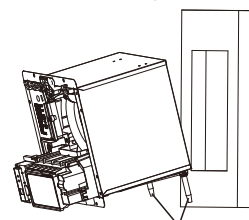
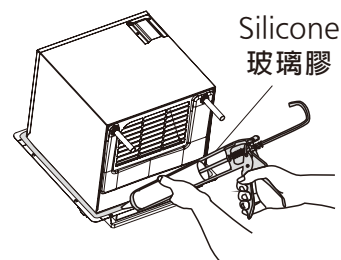
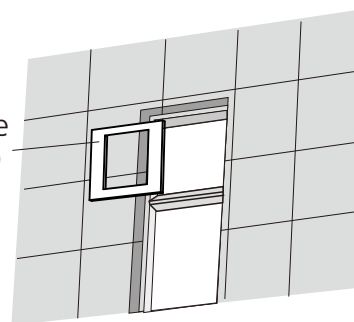

Drain
排水管

- ⑤ Fix the main body onto the window frame with the supplied four $\phi 4 \times 25$ self-tapping screws.
 使用附件包所提供的4顆 $\phi 4 \times 25$ 的自攻螺絲，將機體固定於窗櫺。

$\phi 4 \times 25$ self-tapping screws
 自攻螺絲 $\phi 4 \times 25$



Properly install the main body according to the direction indicating label on the main body.
 請按照機體上的方向指示標籤，正確安裝產品。
 Otherwise, it may cause electric leakage.
 否則可能會導致漏電。

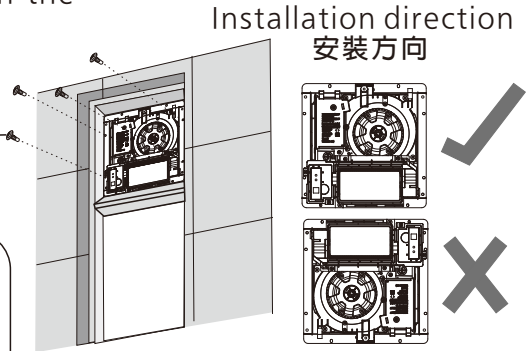

3. Connecting power cord 電源線的連接



- ❗ Please select 60227 IEC 53 ordinary polyvinyl chloride sheathed cord. Nominal cross-sectional area of conductors is $3 \times 1.5 \text{ mm}^2$.
 電源線請選用60227 IEC 53 型軟線，導線的截面積為 $3 \times 1.5 \text{ mm}^2$ 。
- ❗ For the stripping length, please according to the wiring sketch (refer to figure 1). If the stripping length is too long, it may cause short circuit.
 剝線長度，請按照剝線示意圖(右圖1)進行剝線，如剝線過長，可能會導致產品短路。
- ❗ Do not damage the sheath of the power cord, otherwise an electric shock may be caused or short circuit.
 電源線的絕緣膠不能破損，否則可能會導致觸電或短路。
- ❗ Strand the core wire together after stripping, then insert them into about 8 mm deep position of the terminal block, ensuring that the part is under the spring slice, and no copper core cord is exposed outside. Make sure that the copper core cords are fixed by screws reliably (the recommended screw fixing torque is $0.49 \text{ N} \cdot \text{m}$) (See Figure 2.). Otherwise an electric shock may be caused.
 先將剝線後分散的銅芯線絞合在一起，然後伸入到端子台約8 mm深，並確保其在彈簧片的下方，切勿出現銅線外露現象。螺釘擰緊後，請確保銅線不易鬆脫(建議螺釘鎖緊扭矩為 $0.49 \text{ N} \cdot \text{m}$)，否則可能會導致觸電。(右圖2)

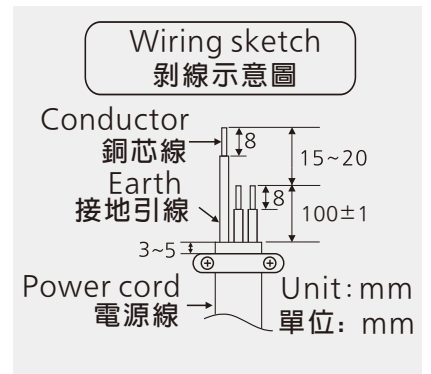

Figure 1
(圖1)

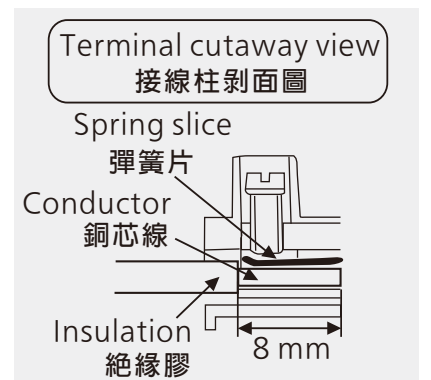

Figure 2
(圖2)

- ① Install an all-pole switch with the contact separation not less than 3 mm and a leakage protection switch (with the leakage current lower than 30 mA) between the fixed wiring and the main body of this product.

請於固定佈線與本產品主機間安裝觸點開距不小於3 mm的“電源全極開關”及漏電保護開關(洩漏電流在30 mA以下)。

Notice 提示事項

Please select the suitable all-pole switch and leakage protection switch according to locally relevant Electricity and Wiring Regulations.

請根據當地相關的電力線路規範選擇合適的“電源全極開關”和“漏電保護開關”。

- ② Remove the screws (2 pcs) on the cord cover, and open the cord cover and the internal cord cover (by pushing the clamping position outward).

取下接線蓋板上的螺絲(2顆), 打開接線蓋板及內接線蓋板。

- ③ Loosen the screws of the cord clip.
- 將固定電源線線夾的螺絲鬆脫。

- ④ Loosen the screws of the pillar terminal, insert the power cord (not supplied) connected to the indoor fixed wiring into the pillar terminal according to the marks, tighten the screw, and guide the wire according to the right figure.

鬆開接線柱上的螺絲, 將接入室內固定線路的電源線(用戶自購)按標註插入接線柱, 擰緊接線柱螺絲, 並按右圖進行理線。

- ⑤ Fix the power cord with the cord clip. (The cord clip must pin the insulation sheath of power cord.)
用電源線線夾將電源線固定。(電源線線夾必須壓住電源線絕緣護套)

- ⑥ Put the internal cord cover and the cord cover back on, and use the screw removed in Step ② to fix the cord cover again.

將內接線蓋板及接線蓋板重新蓋好, 用步驟②拆下的螺絲, 將接線蓋板重新固定。

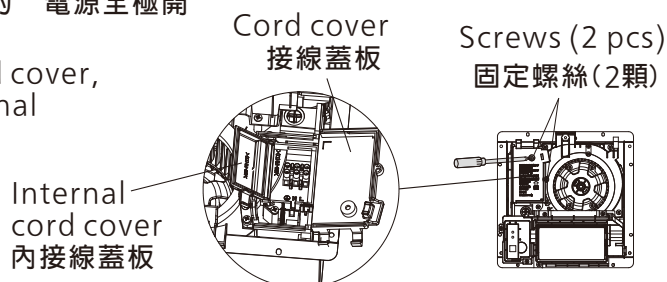
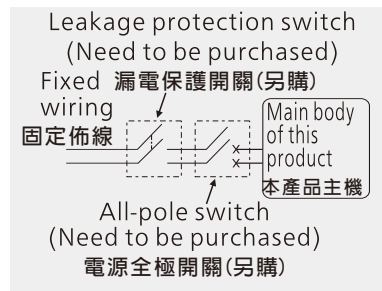
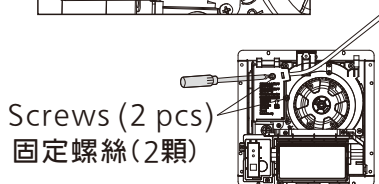
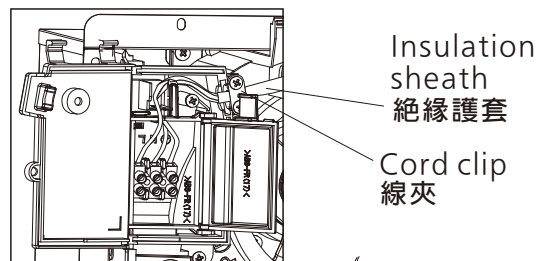
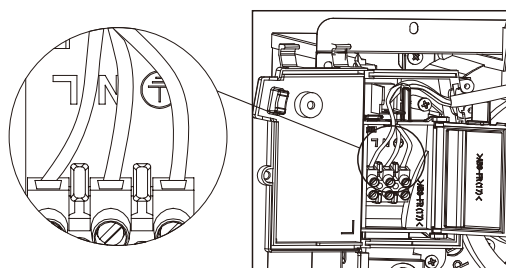
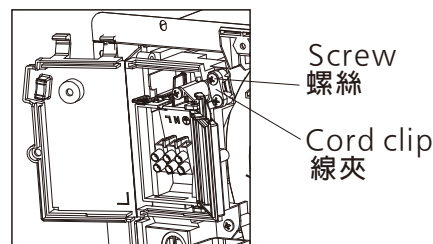

Diagram with the cover removed
打開後示意圖



- ⑦ A power cord lead-out position is set at both the left and right sides of the main body, select one as required.

機體的左右兩側各設有一個電源線引出位，請根據實際情況進行選擇。

In the case of right wiring:
右側出線時：

- ① Remove power cord clip.
將電源線線夾拆下。

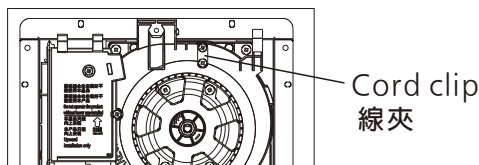

- ② Fix the power cord with power cord clip.
用電源線線夾固定電源線。

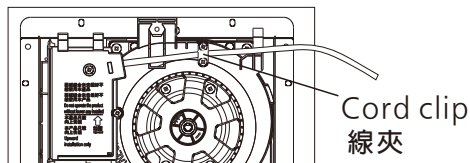

In the case of left wiring:
左側出線時：

Pull the power cord into the buckle of terminal cover.
把電源線扣入接線蓋上的線扣內。

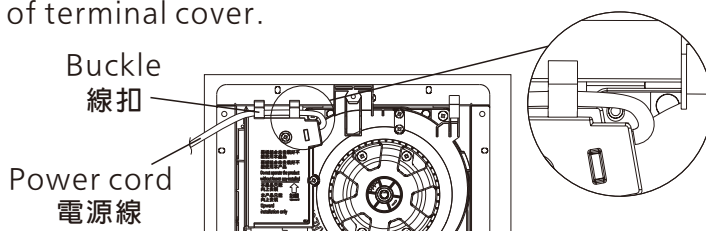
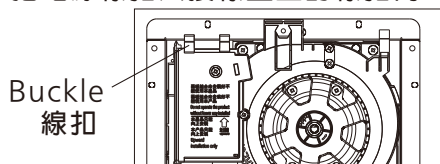

Notice
提示事項

Please lead out the power cord as the figure position shown in the figure. Otherwise, the filter may be unable to be installed.

請儘量按圖示位置引出電源線，否則可能會導致過濾網無法安裝。

4. Installing louver assembly 面板組合安裝

- ① At the power cord lead-out side (left or right), cut the outlet of the louver assembly by tools according to the groove shape on the back (nipper pliers) of the body assembly. (Take left outlet of power cord for example)

面板組合的左右兩邊各設有一個電源線出線口，使用工具(如尖嘴鉗等)按照出線口的凹槽形狀剪出電源線引出側的出線口。(以左側出線為例)

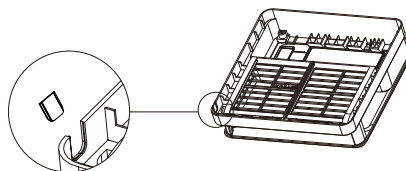

Notice
提示事項

Please remove the burrs of wire outlet before leading out the power cord. Otherwise the power cord may be damaged.

請把出線口的披鋒處理後再引線，否則披鋒可能會割傷電源線。

- ② Pull out the filter assembly.
將過濾網組合抽出。

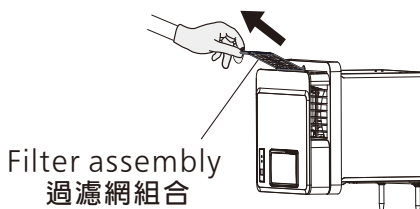

- ③ To install louver assembly, first clamp the card slots in bottom louver assembly in the grooves on the bottom main body. Then clamp the hook in upper part of louver assembly in the fixing position on the upper part of main body

安裝面板組合，先把面板組合底部卡位卡入機體底部凹槽，再把面板組合上部的掛鉤卡入產品上部。

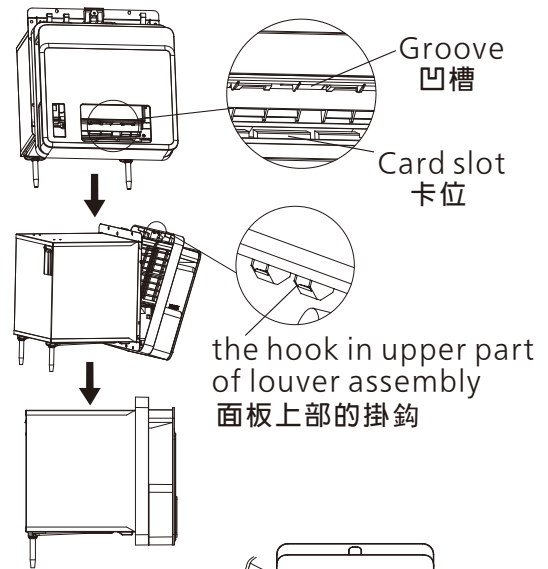

- ④ Make sure that the power cord is led out from the corresponding louver assembly outlet.

確保電源線從相應的面板組合出線口引出。

In the case of left wiring:
左側出線時:

- ⑤ Fix the louver assembly onto the main body with the supplied one M4×10 machine screws.

使用附件包所提供的1顆M4×10的機械螺絲，將面板組合固定於機體。

M4×10 machine screws
機械螺絲
M4×10

- ⑥ Install the filter assembly.

裝上過濾網組合。

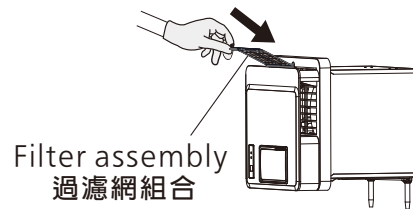

5. Installing the remote control 遙控器的安裝

- ① Remove the remote control, and then remove the controller holder together with the bottom box cover of the remote control.

先將遙控器取下，再將遙控底座與遙控底盒蓋拆下。

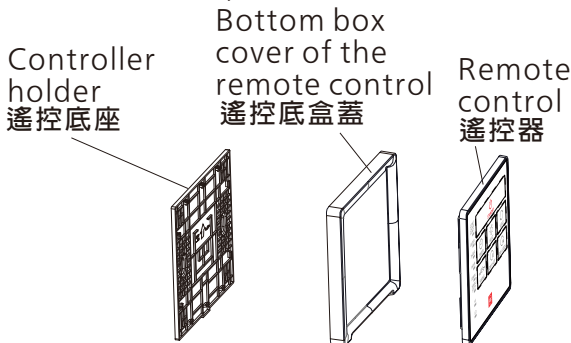

CAUTION
注意



Do not install the remote control in a place where it is easily splashed by water. Otherwise, electric leakage may be caused.
禁止將遙控器安裝在容易被水濺到的地方，否則可能會導致漏電。

② To install the remote control on the wall.

安裝在牆上。

Drill two $\varnothing 8$ mounting holes in the bathroom wall, as shown in the figure below. Make sure that the mounting position is kept away from direct spraying of the shower. Then fix the remote control with two $\varnothing 4 \times 16$ mm screws. (Install the remote control in the direction of the "UP" symbol.)

在浴室的牆壁上開2個 $\varnothing 8$ 的安裝孔，如下圖所示，安裝位置應避免在花灑直淋處，用2顆 $\varnothing 4 \times 16$ mm的螺絲進行固定。(按“向上UP”的標誌方向進行安裝)

2- $\varnothing 8$ Depth 22 mm
2- $\varnothing 8$ 深22 mm

$\varnothing 4 \times 16$ mm self-tapping screw
自攻螺絲 $\varnothing 4 \times 16$ mm

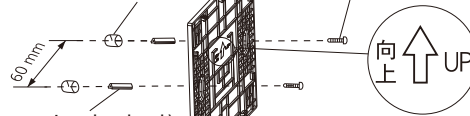

Plastic plug $\varnothing 8 \times 16$ mm (Not included)
膠塞 $\varnothing 8 \times 16$ mm (另購)

③ Close the bottom box cover of the remote control and the controller holder, and check that the buckle on each side is locked. (Install the remote control in the direction of the "UP" symbol.)

將遙控底盒蓋和遙控底座合上，檢查各邊的扣位已經扣上(按“向上UP”的標誌方向進行安裝)。

④ Pull in the remote control and the bottom box cover of the remote control.

將遙控器和遙控底盒蓋吸合。

Bottom box cover of the remote control
遙控底盒蓋

Remote control
遙控器

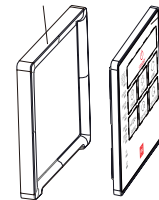
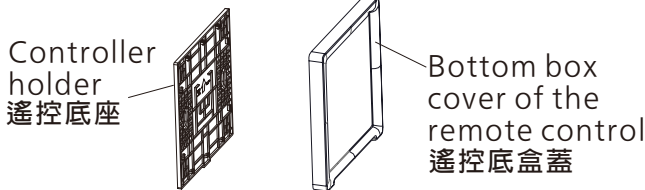

How to use the remote control

遙控器使用方法

Incorrect use of the battery may cause heating, rupture, injury or product failure. Be sure to observe the following instructions.

錯誤使用電池可能會產生發熱、破裂，導致受傷或產品故障，請務必遵守以下事項。

WARNING 警告

- Keep such articles as watches and credit cards away from the remote control since it has a built-in magnet.

遙控器有內置磁鐵，手錶、信用卡等不要靠近。



The magnetic force of the magnet may cause functional damages to watches, credit cards, etc.

磁鐵的磁力可能導致手錶、信用卡等的機能損壞。

- Please make sure that anyone with a medical pacemaker keep the implantation site away from the remote control since it has a built-in magnet.

遙控器有內置磁鐵，使用醫療用起搏器的顧客不要讓起搏器的植入部位靠近。



Otherwise, the pacemaker may be negatively affected.

可能會對起搏器造成不良影響。

WARNING 警告

■ Do not put the battery in reach of children and infants.

禁止將電池放置在嬰幼兒可觸及到的地方。

⊘ If the battery is swallowed, seek medical help immediately.
萬一錯誤吞食，請從速求診。

■ Do not put battery into fire or heat, break, modify it.

禁止將電池投入火中及加熱、分解、改造。

⊘ If the insulation or exhaust value is damaged, the battery may become hot, crack.

如損傷了絕緣物或排氣閥等，可能會導致電池發熱、破裂。

Please remove the adhesive tape before using the remote control for the first time. (According to the method for replacing the battery, after removing the battery cover, remove the adhesive tape without removing the battery.)

初次使用前請去除膠紙。

(按電池更換方法，取下電池蓋后，去除膠紙，不用取下電池。)



■ How to replace the battery (when a CR2032 battery is used.)

電池更換方法(使用CR2032型號電池。)

① Pry the battery cover up in the groove using a flat-head screwdriver.
用一字螺絲刀在凹槽往上撬開電池蓋。

② Replace the battery. Put the battery into place with ⊕ facing upward.
更換電池
將電池 ⊕ 向上放入電池固定位。

③ Install the battery cover.

Put the battery cover into the remote control, and then press on the middle position of the battery cover until a "click" is heard.

安裝電池蓋

將電池蓋放入遙控器中，再按壓電池蓋中間位置，并聽到“滴答”一聲。

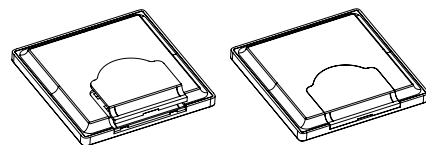
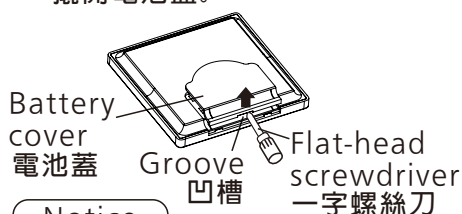

Notice 提示事項

1. If you will not use the remote control for a period of time, take out the batteries.
長期不使用時，請取出電池。
2. Do not replace the batteries when the remote control body is wet.
更換電池時，請擦乾遙控器機體後進行更換。
3. Please be careful with picking up remote control, to avoid dropping and cause damage.
拿取遙控器時請小心，以免遙控器掉落導致損壞。
4. Please don't immerge the remote control into water.
請勿將遙控器浸入水中。
5. Please comply with local laws and regulations when dispose the battery.
丟棄電池時，請遵循當地法律法規。

TEST RUN

試運轉

■ After the installation, turn on the power supply, pair* the remote control with the product, and then press functional buttons to check the following items:

安裝完成后，接通電源，遙控器對碼*後按動各個功能按鈕，檢查以下項目：



■ Does the fan revolve normally?
14 扇葉是否正常旋轉？



■ Does it have abnormal vibration or noise?
是否有不正常的震動或者噪音？

■ Does it blow out hot air?
是否有熱風輸出？

■ Is each button on remote control perform its right function?
遙控器上的各個功能按鈕的功能是否正常？

遙控器上的各個功能按鈕的功能是否正常？

※ The remote control must be paired with the product before use. Within one minute after the product is powered on, press and hold the buttons  +  on the remote control for 3 seconds to complete the pairing process. When the pairing is successful, three beeps will be heard. (If the remote control was just replaced, power off and restart the product and then repeat the above pairing procedure.)

遙控器需要對碼才能使用，在產品通電1分鐘內，同時長按3秒遙控器  +  按鍵，完成產品對碼，對碼成功後會有3聲蜂鳴聲響起。(如更換遙控器，產品需斷電重新啟動，並重複上述對碼步驟。)

※ When two or more thermo ventilators of the same model are installed in the nearby area, the RF remote control may be paired with more than one thermo ventilator at the same time. Therefore, please make sure that each thermo ventilator is installed with an independent "omnipolar power switch" according to the requirements and check that only one thermo ventilator is powered on for each pairing.

當附近區域安裝有2台或以上相同型號的浴室換氣暖風機時，使用遙控器實施對碼操作，其可能會與2台或以上相同型號的暖風機同時對碼，影響使用，所以請務必按照要求，為每台暖風機安裝獨立的“電源全極開關”，並確保只通電1台暖風機進行對碼。

FUNCTION OF REMOTE CONTROL

遙控器功能

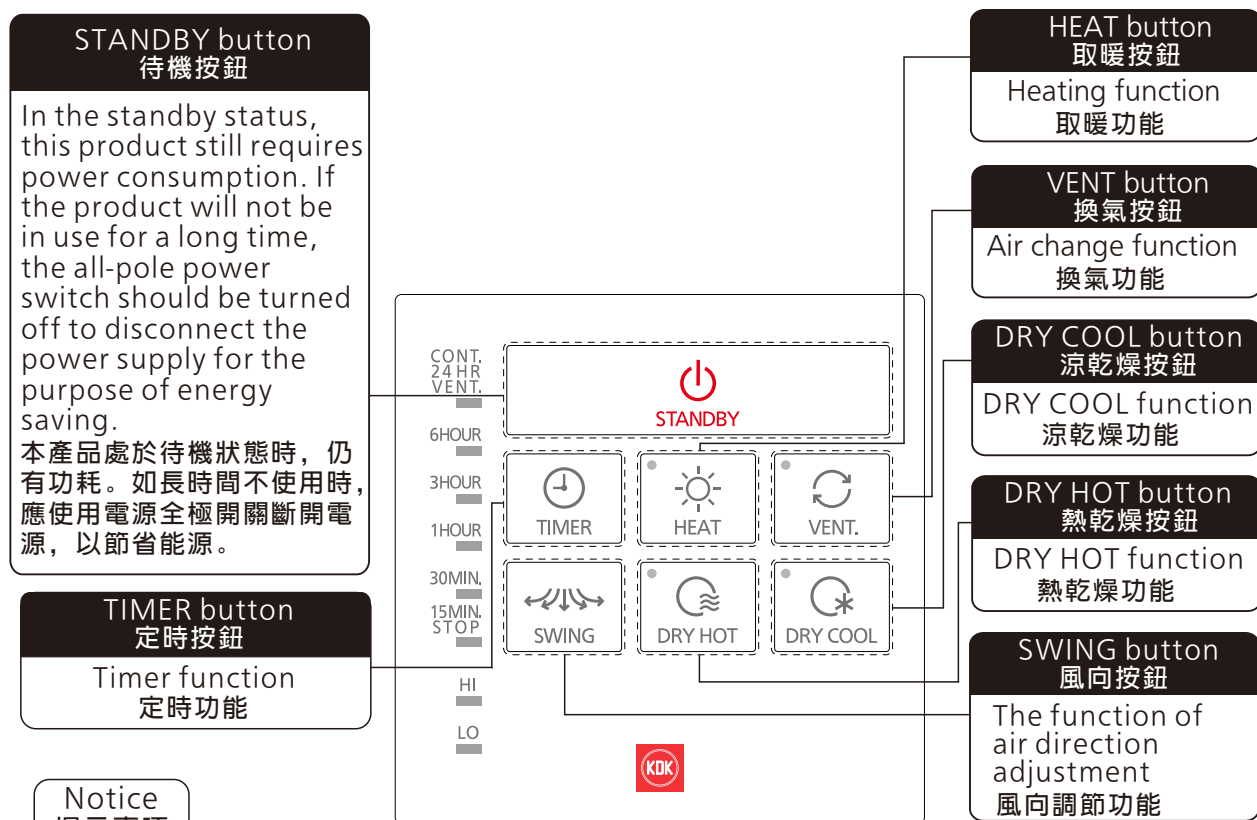

When using heating function for a while, press the  button to stop the heater. The fan will stop running after a delay of 10 seconds.

當使用加熱器功能一定時間後，按  按鈕，加熱器將先停止工作，扇葉延時10秒後再停止工作。

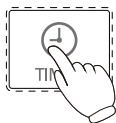

For running time adjusted

調整運轉時間時使用

① During running, you can press the  button to change the running time. Each time you press the button, the time will change once.

運轉中可通過  調整運轉時間，每按一次運轉時間會變換一次。

② The system will automatically memorize the last running time of each mode.

自動記憶每個模式上一次設置的運轉時間。

To cancel the automatic memory content, Press and hold the  button for 3 seconds.

長按  按鈕3秒可解除記憶功能。

HEAT mode 取暖模式		
15 MIN.	~ 3 HOUR	Default settings 出廠設置為 15 MIN.
VENT. mode 換氣模式		
15 MIN.	~ 6 HOUR ~ CONT.	Default settings 出廠設置為 15 MIN.
DRY HOT mode 熱乾燥模式		
15 MIN.	~ 6 HOUR	Default settings 出廠設置為 15 MIN.
DRY COOL mode 涼乾燥模式		
15 MIN.	~ 6 HOUR ~ CONT.	Default settings 出廠設置為 15 MIN.

HOW TO USE AIR DIRECTION FUNCTION 風向功能的使用方法

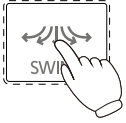

For air direction adjusted 調整風向時使用

During running, you can press the  button to adjust the air direction.
運轉中可通過  按鈕，調整風向。

- ① The initial air direction setting of HEAT, DRY HOT and DRY COOL is AUTO mode. You can press the  button to change the mode between FIX and AUTO.

取暖、熱乾燥、涼乾燥的風向初始設置為自動模式，通過  鍵，可進行固定與自動模式的切換。

- * AUTO mode: The baffle plate circularly swings within the range of about 30° to 90°

自動模式：導風板在約30度~90度的範圍內循環擺動。

- * FIX mode: To fix the baffle plate angle, press the  button then the baffle plate turns to the required position. The baffle plate will stop.

固定模式：需固定導風板角度時，待導風板轉到所需位置，按  按鈕，導風板將停止轉動。

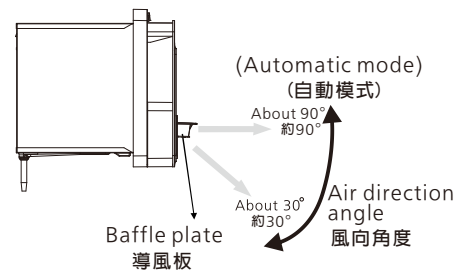

- ② Air direction cannot be set in the ventilation mode.
換氣模式不可進行風向設置。
- ③ Each mode will automatically memorize the air direction position set this time.

各模式會自動記憶本次所設置的風向模式。

To cancel the automatic memory content, press and hold the  button for 3 seconds.

取消自動記憶內容，請長按  按鈕3秒。

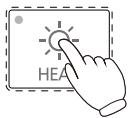

Used when you feel cold in a bath

在浴室中感到冷時使用

Before taking a bath, start the heating function to warm the bathroom beforehand.

在沐浴前開取暖功能，可提前把浴室加溫。

① Press the  button to start the heating mode at the HI mode.

It will switch to the LO. mode if you press this button again.

按  按鈕，取暖模式以強檔開始運轉，再按一次切換為弱檔。

(Initial settings)
(初始設置)

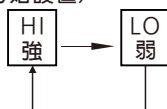

② During running, you can press  to change the set time.

運轉過程中，可通過  調整設置時間。

③ During operation, you can press the  button to change the air direction.

運轉過程中，可通過  按鈕，調整風向。

④ This product will stop automatically when the set time is up.

運轉完所設置時間後，本機會自動停止。

⑤ To stop midway in running, press the  button.

如需在運轉途中停止，請按  按鈕。

※ In the heating mode running for 30 seconds above, press the  button to stop the heater. The fan will stop running after a delay of 10 seconds.

若在取暖模式運轉30秒以上，按  按鈕後，為使加熱器冷卻，扇葉將延遲10秒停止運轉。

1. Hot startup function: After the product starts up in the heating mode when the temperature in the bathroom is lower than 20 °C, it enters the hot startup status to avoid blowing of cold air, and the fan runs at a low speed. When the temperature in the bathroom reaches 20 °C or above or after running for 60 seconds, the hot startup status stops and the fan runs at a high speed.

熱啟動功能：當浴室溫度低於20 °C時，以取暖模式啟動後，為避免冷風吹出，產品進入熱啟動狀態，扇葉以低速運轉，待浴室溫度達至20 °C以上或經過60秒後，熱啟動狀態停止，扇葉以高速運轉。

2. Heater may stop heating when temperature in bathroom is up to required degree, and may restart heating as the temperature in bathroom cools down.

當浴室內溫度上升到一定程度時，加熱器停止工作，待溫度下降到一定程度後，加熱器重新開始工作。

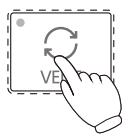

Used to ventilate the bathroom
浴室換氣時使用

- ① Press the  button to start the ventilation mode at the HI mode.
It will switch to the LO. mode if you press this button again.

按  按鈕，換氣模式以強檔開始運轉，再按一次切換為弱檔。

(Initial settings)
(初始設置)

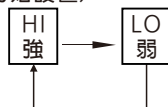

- ② During running, you can press  to change the set time.
運轉過程中，可通過  調整設置時間。
- ③ This product will stop automatically when the set time is up.
運轉完所設置時間後，本機會自動停止。
- ④ To stop midway in running, press the  button.
如需在運轉途中停止，請按  按鈕。





HOW TO USE DRY HOT/COOL FUNCTION 熱/涼乾燥功能的使用方法



Used when you need to dry the bathroom or clothes
乾燥浴室或乾衣物時使用

- ① Press the  or  button to start the DRY HOT or DRY COOL mode.

按  或  按鈕，熱乾燥或涼乾燥模式開始運轉。

- ② During running, you can press  to change the set time.
運轉過程中，可通過  調整設置時間。
- ③ This product will stop automatically when the set time is up.
運轉完所設置時間後，本機會自動停止。
- ④ To stop midway in running, press the  button.
如需在運轉途中停止，請按  按鈕。

※ In the DRY HOT mode running for 30 seconds above, press the  button to stop the heater. The fan will stop running after a delay of 10 seconds.

若在熱乾燥模式運轉30秒以上，按  按鈕後，為使加熱器冷卻，扇葉將延時10秒停止運轉。

HOW TO USE DRY HOT/COOL FUNCTION 熱/涼乾燥功能的使用方法

To use the drying function to dry clothes, you are suggested to install the product as shown below:

使用乾燥功能進行衣物烘乾時，建議按照下圖進行安裝：

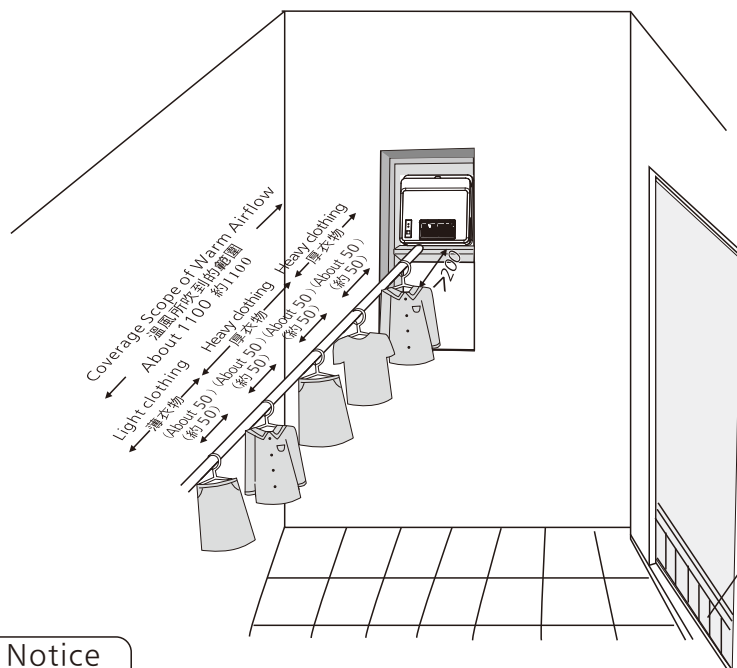

To make the effect of drying clothes better, please set a ventilation shutter at the lower part of the door with a valid opening area of 100 cm² or above.
為使乾衣效果更好，建議在門下部設置有效開口面積應在100 cm²以上的換氣用百葉窗。

Notice 提示事項

- When water drops remain on the bathroom walls or the floor, the clothes drying time will be prolonged. Use a dry cloth to wipe away water drops in advance.
浴室牆壁或地板殘留水滴時，會導致衣物乾燥時間延長，請事前用乾布等擦拭乾淨。
- To spread the warm airflow, keep a space (more than 50 mm) between clothes.
為使溫風遍佈，衣物間要保留間隔(50 mm以上)。
- Hang heavy clothing near the warm airflow outlet to dry them more quickly.
厚衣物掛在溫風出風口附近會更易乾。
- The clothes must be 200 mm or above away from the air outlet. (The clothes may be discolored if the distance is too short.)
衣物離出風口必須保證在200 mm以上。(如果太近可能會導致衣物變色)
- The clothes at the back end of the clothesline pole cannot be dried quickly. In the midway of drying, you can swap the positions of fast-drying clothes near the product with those at the back end. (In the case of Auto air direction, the scope of about 1100 mm at the center is easily reached by the airflow, as shown in the figure.)
衣桿後端的衣物不易乾，在乾燥中途可將易乾的靠近產品端的衣物與後端衣物調換位置。(風向自動時，如圖所示中央約1100 mm為風易吹到的範圍。)
- Do not hang the clothes on product directly to dry.
請勿把衣物直接掛在產品上乾燥。
- The drying time varies with the bathroom size and type, room temperature, outside temperature and humidity, clothes types and quantities, and the dewatering status.
乾燥時間會因浴室的大小、種類、室溫、外界溫度、濕度、衣物種類、數量、脫水狀態而不同。
- Since the product performance cannot be fully brought into play in the bathroom with poor airtight and heat resistance, you need to set a longer drying time.
密閉性、斷熱性不好的浴室，因產品的性能不能充分發揮，請將乾燥時間適當設置長一點。

HOW TO USE DRY HOT/COOL FUNCTION 熱/涼乾燥功能的使用方法

Notice 提示事項

- When you dry clothes, make sure that the air blows to the clothes.
乾衣時，請確保風能夠吹到衣物。
- Condensation may happen as this is natural phenomenon due to specific weather and bathroom condition. It is recommended to use Ventilation mode to remove excess moisture after clothes drying.
在特定的天氣條件及浴室環境下，乾衣時浴室內會有結露的情況，這屬於正常現象。為了消除乾衣過程產生的濕氣，建議在乾衣完成後開啟換氣模式。

Installing the clothesline pole 需安裝掛衣桿時

Cautions for Installing clothesline pole:
安裝掛衣桿注意事項：

- Please select clothesline pole of rust resisting material which can withstand more than 5 kg load.
選購掛衣桿時，請務必選購每根可承受5 kg以上重量的不易生鏽的衣桿。
- Do not hang the clothesline pole on product directly.
請勿把掛衣桿直接搭在產品上。
- Be sure to install clothesline poles at the recommended position.
(The drying time will be prolonged if you install them at other positions.)
掛衣桿必須安裝於所推薦的位置。(如安裝於推薦以外的位置，會導致乾衣時間延長。)
- Do not set the clothes hook in an inclined condition. (Otherwise the distance of 200 mm away from the main body may not be insured.)
不要將衣掛傾斜放置。(否則可能不能確保與機體間的距離200 mm。)
- Make sure that the clothes rail and the product maintain a distance of more than 100 mm.
確保掛衣桿與產品保持100 mm以上的距離。

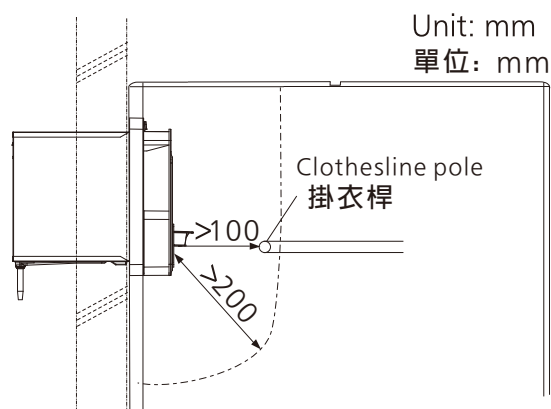

WARNING 警告

- ! This appliance is intended only for drying textiles washed in water.
器具僅用於乾燥水洗的紡織物。
Otherwise, it may cause injury.
否則可能會導致傷害。

CAUTION 注意

- ⊘ Do not leave clothes too close to the air outlet.
禁止將衣物離出風口太近。
Otherwise, a fire may be caused.
否則可能會導致火災。

When the remote control is lost or does not work, you can use the MODE button panel on the front surface of the main body to operate the product.

(Each time can be operated 15 mins)

當遙控器丟失或者無法正常使用時，可臨時通過機體面板正面的模式按鈕進行操作。
(每次可運轉15分鐘)

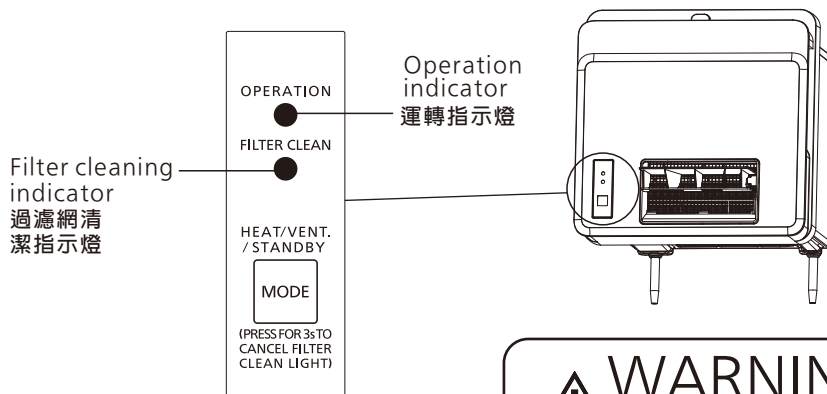

The MODE button can be used to switch among the following functions:

模式按鈕可進行下記功能的切換：



WARNING
警告

⚠

Do not press the MODE button during a bath or shower in the bathroom. Otherwise, you may slip.
避免意外滑倒，當在浴室沐浴時，請不要操作模式按鈕。

Conditions of the filter cleaning indicator and running indicator.

過濾網清潔指示燈及運轉指示燈的變化。

Operation Status 運轉狀態	Filter cleaning indicator 過濾網清潔指示燈	Operation indicator 運轉指示燈
Stop 停止	Off 滅	Off 滅
Normal operation 正常運轉	Off 滅	On 亮
Abnormal operation 運轉異常	Off 滅	Blinking fast*1 快速閃爍
Normal operation 正常運轉 + Filter cleaning indication 過濾網清潔提示	Blinking fast 快速閃爍	On 亮
During the hot startup 熱啟動功能時	Off 滅	Blinking slow*2 慢速閃爍

The product error means that a fault occurs or the main body fails to operate normally, when the operation indicator blinks quickly. Please disconnect the power supply, and contact customer consultation service center or your distributor.

產品異常主要指出現故障或主機失常時，運轉指示燈快速閃爍，請斷開電源，且與客戶諮詢服務中心或經銷商聯繫。

※1 Blinking fast: On for 0.5 seconds and off for 0.5 seconds
快速閃爍：0.5秒亮、0.5秒滅。

※2 Blinking slow: On for 1.5 second and off for 1.5 second
慢速閃爍：1.5秒亮、1.5秒滅。



WARNING

警告

- To avoid low-temperature scalding, do not directly below the same part of the body with hot wind for a long time (2 hours or above).

請勿長時間(2小時或以上)讓熱風直接吹在身體同一位置。

- ⊘ Doing this may lead to low-temperature scald.
可能會導致低溫燙傷。

- Once flammable gas leaks, do not start any function of this product.

當發生煤氣洩漏時，禁止開啟本產品的任何功能。

- ⊘ Doing this may generate spark and thus lead to explosion.
可能會產生火花而引起爆炸。

- Do not directly spray this product with water and other liquids.

禁止用水及其他液體直接噴射本產品。



Doing this may lead to short circuit or electric shock.
可能會導致短路或觸電。

- Do not clean the heating part or let water flow into the electric motor or electrical parts.

禁止清潔加熱部件，且切勿讓水進入電動機及電器部件內。

- ⊘ Failure to following this may lead to electric shock.
否則可能會觸電。

- Do not put battery into fire or heat, break, modify it.

禁止將電池投入火中及加熱、分解、改造。

- ⊘ If the insulation or exhaust value is damaged, the battery may become hot, crack.

如損傷了絕緣物或排氣閥等，可能會導致電池發熱、破裂。

- Do not put the battery in reach of children and infants.

禁止將電池放置在嬰幼兒可觸及到的地方。

- ⊘ If the battery is swallowed, seek medical help immediately.
萬一錯誤吞食，請從速求診。

- Please promptly take out of the exhausted battery from the remote control.

用完的電池，請及時從遙控器中取出。

- ⊘ Otherwise, battery may leakage or become hot, crack.
如放置不管，有可能會導致電池漏液或發熱、破裂。

- If the alkaline liquid of battery enter eyes, clean the eyes with lots of water and seek medical help immediately, but not rub eyes with hands.

電池的鹼性液體不慎進入眼內時，切勿用手揉擦眼睛，迅速使用大量清水充分洗淨和醫治。

- ⚠ Otherwise, it may cause blindness, etc.
否則可能會導致失明等。

- Before try to touch the main body of this product or clean this product, make sure that the "all-pole switch" connected to this product is disconnected.

在接觸本產品機體前和清潔本產品時，必須確保連接本產品的“電源全極開關”處於斷開狀態。

- ⚠ Failure to following this may lead to electric shock.
否則可能會觸電。

WARNING 警告

- If the product will not be in use for a long time, please use the “all-pole power switch” to disconnect the power supply.

不使用產品時，請斷開“電源全極開關”。



Failure to following this may lead to electric shock.
否則可能會觸電。

- If you will not use this product any more, remove the product. 如以後不打算再使用本產品時，不得放置不管，而應予以拆除。



This product may cause injuries once it falls off.
萬一掉落，可能會導致受傷。

- Please observe the following with using the batteries.

電池的使用請遵守以下內容。

- Do not inversely install the positive pole and negative pole of batteries. 勿將電池正負反裝。
- Do not short circuit. 不可短路。



Otherwise, a leakage or damage may be caused.
否則可能會導致漏液或破損。

- Do not disassemble this product for repair or reconstruction. 禁止拆解本產品進行修理或改造。



Doing this may lead to fire and electric shock.
容易導致火災、觸電。

CAUTION 注意

- When you clean this product, please wear gloves. 清潔時請帶上手套。



Failure to follow this may lead to unexpected injury.
否則可能會導致受傷。

- Do not swing the baffle plate when the product is electrified. 在機體通電狀態下，請勿用手調整導風板。



Failure to follow this may lead to unexpected injury.
否則可能會導致受傷。

Notice 提示事項

1. Do not swing the baffle plate when the product is electrified, otherwise the baffle plate may operate in inaccurate angles.

在機體通電狀態下，請勿用手調整導風板，否則可能會導致導風板無法按正確角度運轉。

When the baffle plate cannot be reset completely, you can press the STANDBY button immediately after pressing the DRY COOL button. Then, the baffle plate will be reset by a small angle. Repeat the operation until the baffle plate is reset completely.

當出現導風板復位不完全時，可通過按“涼乾燥”鍵後，立即按“待機”鍵，導風板將進行一個小角度的復位，如此重複操作，直到使導風板完全復位為止。

USE AND MAINTENANCE INSTRUCTIONS 使用及維護注意事項

- The applicable ambient temperature of this product is in the range of $-10^{\circ}\text{C}\sim 40^{\circ}\text{C}$, using it out of this range may cause a fault.
本產品適用環境溫度 $-10^{\circ}\text{C}\sim 40^{\circ}\text{C}$ ，否則可能會引起故障。
- Please stop operating the product during typhoon or similar weather with strong wind and rain.
颱風等強風雨天氣時，請停止使用本產品。

HOW TO MAINTENANCE

維護方法

Cleaning Precautions 清潔注意事項

Cleaning the louver: 面板組合的清潔:

- To prevent color change and accelerated aging of the panel, do not use any type of diluent, alkaline cleaner, benzene, alcohol, antiseptic, or steel ball as shown in the figure.

為避免導致面板變色及加速面板老化，請勿使用類似於圖示的各種稀釋劑、鹼性清潔劑、苯、酒精、殺菌劑或鋼絲球等。



- To use a chemical cloth, clean this product by following the instructions.
如使用化學抹布，請遵照其使用指示來清潔本產品。

Cleaning the filter: 過濾網的清潔:

- Do not wash the filter with water, because water may destroy the anti-microbial performance of the filter; do not use a wire brush or any other hard tool to clean the filter, lest the filter would be damaged.
不可用水洗，因為水會破壞過濾網的抗菌性能；不可用鋼絲刷或其他硬質的工具來清潔以免損壞過濾網。
- When the filter cleaning indicator at the receiving part of the main body blinks, it is time to clean the filter according to setting of the main body. You need to clean the filter. (When the accumulated running duration reaches 2,200 hours (continuous running about three months), the filter cleaning indicator will blink.)
當機體接收部的過濾網清潔指示燈閃爍時，表示已達到機體所設定的清潔過濾網的時間，請清潔過濾網。（當運轉時間累計達到2200小時（約連續運轉3個月），清潔指示燈就會閃爍。）
- To prevent dust accumulation in the filter which may block the air inlet, be sure to clean the filter before starting the product when product has not been in use for a period of time, even if the filter cleaning indicator does not blink. Also, when the product is not often used, clean the filter regularly even if the filter cleaning indicator does not blink.
為防止灰塵積聚在過濾網上導致進風口堵塞，產品放置一段時間未使用時，即使過濾網清潔指示燈未閃爍，也請清潔過濾網後再運轉產品；產品使用頻率較低時，即使過濾網清潔指示燈未閃爍，也請定期清潔過濾網。

- Shut off the all-pole switch.
斷開“電源全極開關”。
- Wipe the front panel and the panel base with a soft cloth.
用軟布擦拭前面板及面板底座。

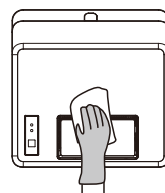

- ③ Remove the filter assembly from the slant upward side of louver assembly.
將過濾網組合從面板組合的斜上方取出。

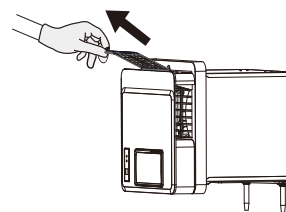

- ④ Use a vacuum cleaner to remove dust and dirt from the filter.
用吸塵器清除過濾網上的灰塵和污垢。

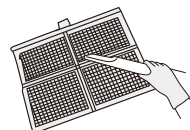

- ⑤ Reinstall the filter assembly.
重新安裝過濾網組合。

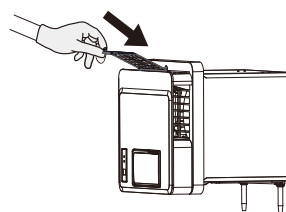

- ⑥ Turn on the all-pole switch.
開啟“電源全極開關”。

- ⑦ Clear the filter cleaning indication at the receiving part of the main body.
取消機體接收部過濾網清潔提示。

Press and hold the MODE button at the receiving part of the unit body for 3 seconds. A “beep” means the filter cleaning indication is cleared. (The accumulated time of the filter cleaning indication will be reset, and the time will be accumulated again.)

長按機體接收部模式按鈕3秒，聽到“滴”的一聲，過濾網清潔提示將被解除。
(過濾網清潔指示的累計時間將復位，重新累計。)

Each time cleaning the filter, you are advised to reset the accumulated time of the filter cleaning indication. (Press and hold the MODE button for 3 seconds. A “beep” means the resetting is done.)

每次清潔過濾網後，建議將過濾網清潔提示的累計時間復位。(長按模式按鈕3秒，聽到“滴”的一聲，復位完成。)

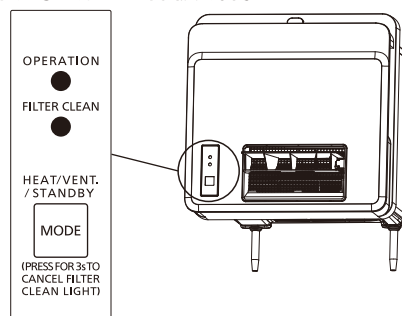

ANTIBACTERIAL FUNCTION

抗菌功能

- ※ The filter mesh in the filter mesh assembly provides the antibacterial function, with the antibacterial ratio against staphylococcus aureus and the antibacterial ratio against colibacillus up to 99.9% respectively (test basis: JIS Z2801:2000)
- ※ After use for a period of time, the colour of the filter mesh will change from white to brown, but the change to material colour will not affect performance.
- ※ As the use time increases, the antibacterial performance of the filter mesh will decrease accordingly.
- ※ 過濾網組合中的過濾網具有抗菌功能，其對金黃色葡萄球菌抗菌率達到99.9%，大腸桿菌抗菌率達到99.9%。(檢測依據：JIS Z2801: 2000)。
- ※ 使用一段時間後，過濾網的顏色會從白色變成茶色，這種材質顏色的變化並不影響性能。
- ※ 隨著使用時間的增加，過濾網的抗菌性能會相應減弱。

Check the product according to the table below if a fault occurs. If an error occurs, check that the all-pole switch connected to this product is disconnected, and contact customer consultation service center or your distributor.

發生故障時請按下表進行檢查，如果問題仍然未能解決，請確保連接本產品的“電源全極開關”處於斷開狀態，且與客戶諮詢服務中心或經銷商聯繫。

	Symptom 癥狀	Cause 原因	Troubleshooting 處理
Air 風	No hot wind blow out 無熱風吹出	The heater may fail 有可能是加熱器不良	Contact customer consultation service center or your distributor 請與客戶諮詢服務中心或經銷商聯繫
	Air volume reduced 風量變小	The filter may be blocked 有可能是過濾網堵塞	Clean the filter 請清潔過濾網
Remote control 遙控器	Remote control does not work 遙控器無法操作	The batteries may be exhausted 有可能是電池電量消耗完	Replace the batteries 請更換新電池
Mode button panel on main body 機體模式面板	The filter cleaning indicator blinks quickly 過濾網清潔指示燈快速閃爍	It's time to clean the filter 到達需清潔過濾網時間	Clean the filter 請清潔過濾網
Main body 機體	Rain water enter into bathroom 有雨水進入室內	The drain pipe may be blocked or installation problem 有可能是排水管堵塞或安裝不良	Contact customer consultation service center or your distributor 請與客戶諮詢服務中心或經銷商聯繫

WIRING DIAGRAM

電氣原理圖

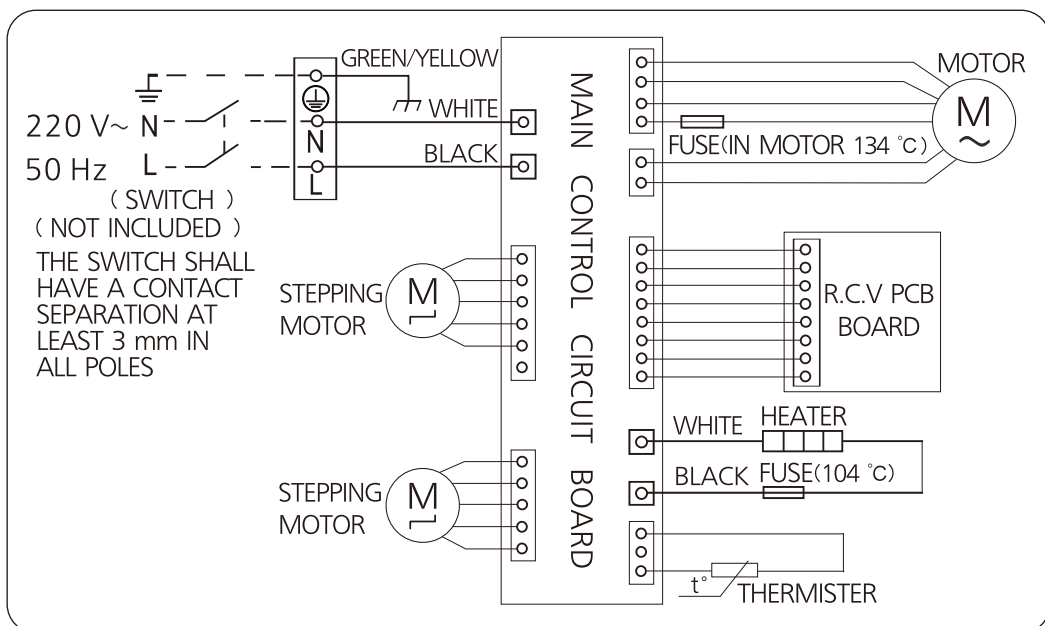

Model No. 型號	Rated Voltage 額定電壓 [V]	Rated Frequency 額定頻率 [Hz]	Power Consumption 額定輸入 總功率 [W]	Rated Current 額定電流 [A]	Air Volume 換氣風量 [m ³ /h]	Weight 淨重 [kg]
23BWDBH	220	50	1400	6.36	220	4.7

Power Consumption 功率 [W]						Noise 噪音 [dB(A)]					
Heat 取暖		Dry 乾燥		Vent 換氣		Heat 取暖		Dry 乾燥		Vent 換氣	
HI 強	LO 弱	Hot 熱	Cool 涼	HI 強	LO 弱	HI 強	LO 弱	Hot 熱	Cool 涼	HI 強	LO 弱
1400	1300	1400	29	34	19	48	46	48	48	48	28

- Power consumption and rated current are obtained when the baffle plate is at maximum opening angle.
額定輸入總功率、額定電流值在導風板打開最大角度時測得。
- Air volume, electric specification and noise value are measured when static pressure is 0 Pa.
換氣風量、電氣特性、噪音值等數據是在靜壓為0 Pa狀態下的數值。
- Noise value is the weighted sound pressure grade A, which is the central value measured by this company, its tolerance range is from +3 dB to -7 dB. The method to measure is as follows: in an anechoic chamber, measure noise value first 1 m away from the left, right and beneath of the sample, then get the averaged value.
噪音值為A計權平均聲壓級，是本公司測試結果的中心值，有+3 dB, -7 dB的公差範圍。測試方法為在全消音噪聲測試室內，距樣品左側、右側、正前方各1米處測定其噪音值，然後取其平均值。
- Air volume is the central value measured by this company with $\pm 10\%$ of tolerance range.
換氣風量是本公司測試結果的中心值，有 $\pm 10\%$ 的公差範圍。
- This product and remote control comply with the IPX4 requirement against the water shower test.
本產品機體及遙控器通過防濺水試驗，符合IPX4要求。
- Insulation class E
E級絕緣

The above specification may be changed without further notice.
上述參數如有變動，恕不另行通知。